

## STQA Supply air diffuser

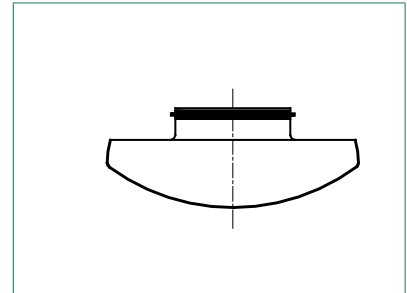
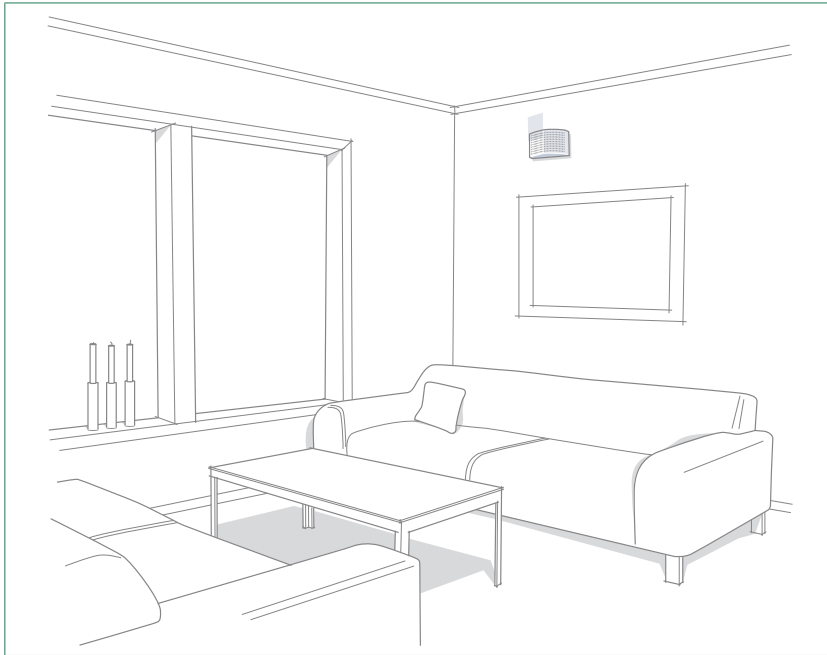

STQA is a very quiet supply air diffuser which is suitable for air distribution in offices, houses and rooms where wall mounting is required. It can be mounted on wall and also close to the ceiling. STQA has a removable front plate for easy cleaning, measuring and adjustment of air flow.

### Quick Selection

with 8 open rows

Diffuser Size	Connection mm	Air flow l/s at sound level		
		25 dB(A)	30 dB(A)	35 dB(A)
STQA-100-C	100	17	20	24
STQA-125-C	125	20	24	28

### Specifications

- CleanVent coating as standard
- Low noise level
- Can be mounted close to the ceiling
- Removable front plate for easy cleaning, measuring and adjustment of air flow

### Product code example

Supply air diffuser STQA-125-C

### Air flow, pressure drop, sound level, throw

STQA-100-C

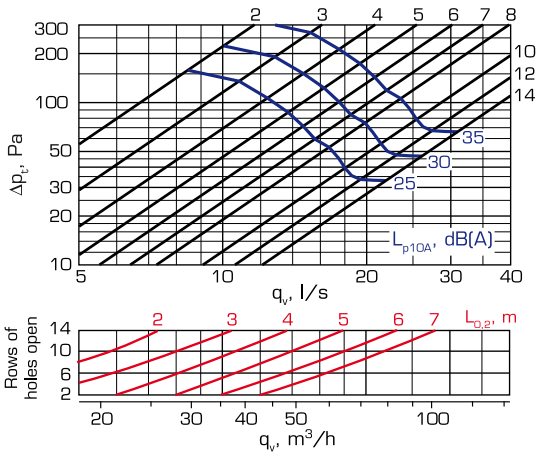

STQA-125-C

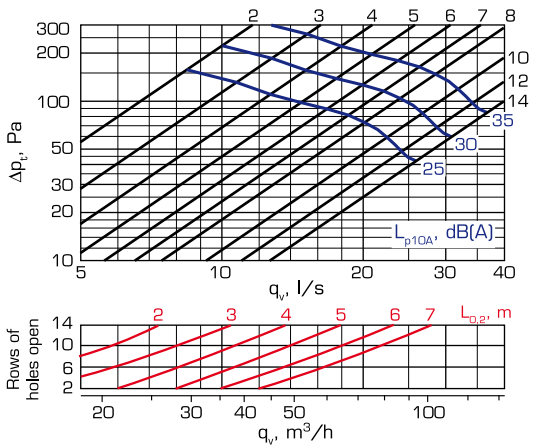

### Acoustical data

Sound power level  $L_w$

STQA	CORRECTION $K_{oct}$ (dB)						
	Middle frequency by octave band (Hz)						
	125	250	500	1000	2000	4000	8000
100	-1	-4	0	0	-2	-11	-14
125	2	-3	-2	-1	-1	-8	-13
Toler. $\pm$	3	2	2	2	2	2	3

Sound attenuation  $\Delta L$

STQA	Rows of holes open	SOUND ATTENUATION $\Delta L$ (dB)							
		Middle frequency by octave band (Hz)							
		63	125	250	500	1000	2000	4000	8000
100	14	19	13	6	0	0	1	3	3
	8	19	13	7	0	0	4	5	5
	2	19	14	7	7	10	7	9	12
125	14	17	12	6	0	0	1	2	3
	8	17	12	6	1	2	4	5	5
	2	19	14	6	6	10	7	10	11
Toler. $\pm$		6	3	2	2	2	2	2	3

Effect of distance X and open rows of holes to the noise level at different connections

$\varnothing 100$	X	Rows of holes open					
		14	8	2	14	8	2
4D	+0 dB	+2 dB	+0 dB	+2 dB	+0 dB	+0 dB	
2D	+3 dB	+4 dB	+2 dB	+4 dB	+0 dB	+0 dB	
OD	+4 dB	+6 dB	+3 dB	+5 dB	+0 dB	+0 dB	

$\varnothing 125$	X	Rows of holes open					
		14	8	2	14	8	2
4D	+0 dB	+0 dB	+0 dB	+0 dB	+0 dB	+0 dB	
2D	+2 dB	+3 dB	+2 dB	+3 dB	+0 dB	+0 dB	
OD	+3 dB	+4 dB	+3 dB	+4 dB	+0 dB	+0 dB	

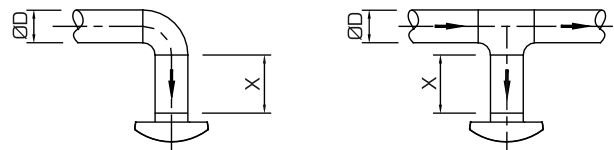

### Diffusion pattern

From top

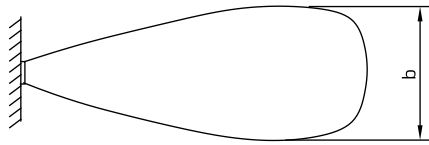

From side

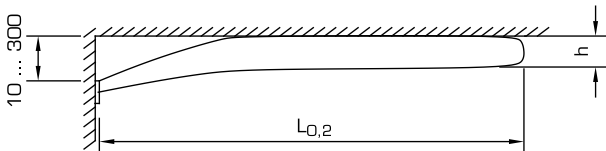

Trow when chilled air is obtained by correction factor k according to the following formula

$$L_{0,2(\Delta t)} = k \times L_{0,2}$$

$\Delta t, ^\circ\text{C}$	b	h	k
0	$0,6 \times L_{0,2}$	$0,07 \times L_{0,2}$	1,0
-7	$0,8 \times L_{0,2}$	$0,15 \times L_{0,2}$	0,7

### Dimensions and weight

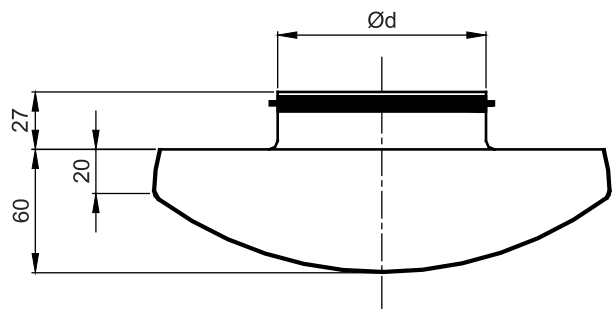
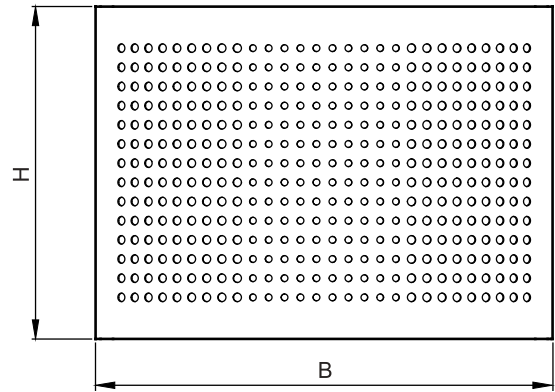

Size	$\varnothing d$ (mm)	B x H (mm)	Weight (kg)
100	98	218 x 156	0.66
125	123	218 x 156	0.65

## General

### Application and function

STQA is a very quiet supply air diffuser which can be mounted on wall and also close to the ceiling. It is suitable for air distribution in offices, houses and rooms where wall mounting is required.

STQA has a removable front plate for easy cleaning, measuring and adjustment of air flow. The body of STQA is equipped with circular rubber sealing gasket joint.

### Installation

STQA is mounted straight to the duct without mounting ring. Fastening is secured with screws to the wall or with pop rivets to the duct. Front plate is fastened to the body with spring clips.

### Measuring and adjustment of the air flow

Air flow measurement is made by measuring the pressure difference from the front plate hole. Adjustment of the air volume is obtained by opening and closing the rows of front plate holes.

### Material and surface finish

The diffuser is made of hot-dip galvanized steel sheet and meets the requirements for corrosivity class C2 in accordance with EN ISO 12944-2.

The diffusers are powder coated, which gives a high surface finish and good impact and scratch resistance.

Standard colour is white RAL 9010. Other colours are available to special order. CleanVent coating as standard.

### Instructions

Instructions for installation, adjustment and maintenance are described in detail in our technical instructions, which are supplied with every product.

The instructions are also available on the internet at [www.flaktgroup.com](http://www.flaktgroup.com).

### Technical data and dimensioning

For complete dimensioning details please see FläktGroup product selection program.

Contact our nearest sales office for further information.

### Descriptive text

Supply air diffuser STQA manufactured by FläktGroup for example in size 100.

## Product code

Supply air diffuser                      STQA - aaa - b

### Size (aaa)

100, 125

### Surface finish (b)

C = Standard CleanVent coating

E = Special colour